

5+

# STANLEY<sup>®</sup> Jr.

## DUMP TRUCK KIT

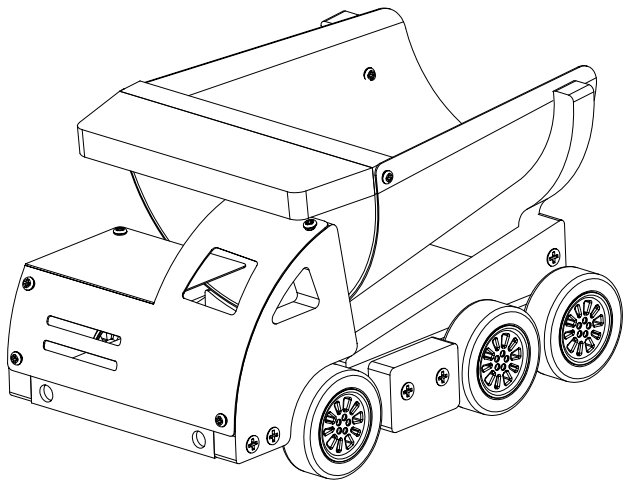

### ASSEMBLY INSTRUCTIONS

ATTENTION! Parental guidance and direct supervision required at all times.

# STANLEY® Jr.

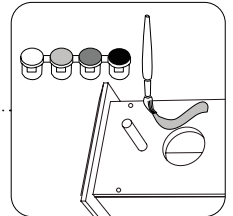
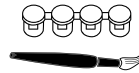
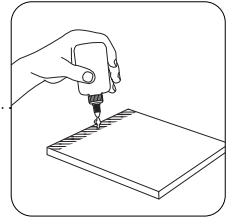
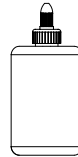
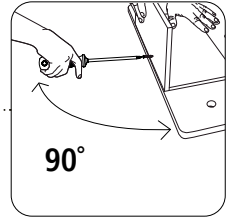
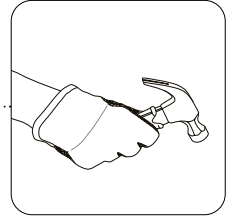
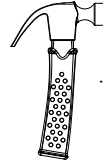

# ASSEMBLY INSTRUCTIONS

60min

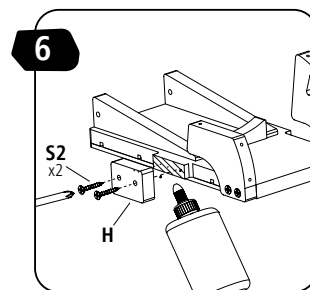
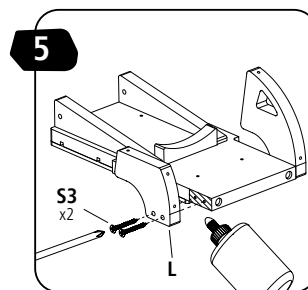
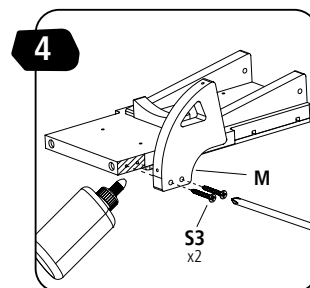
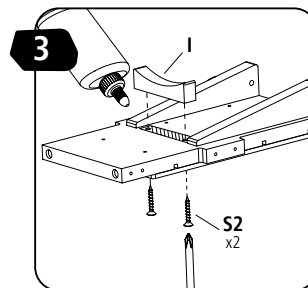
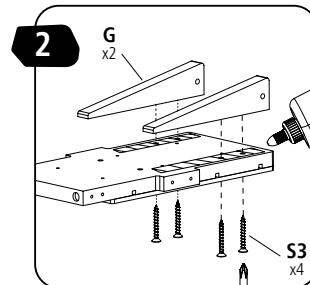
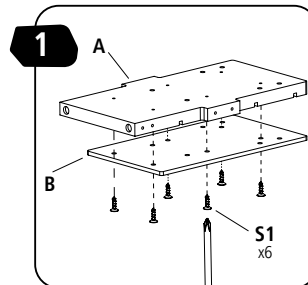
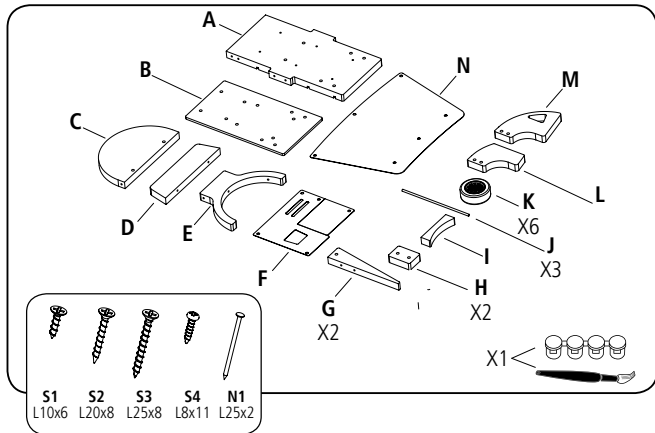
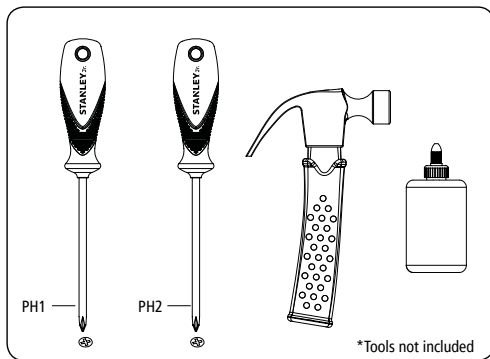

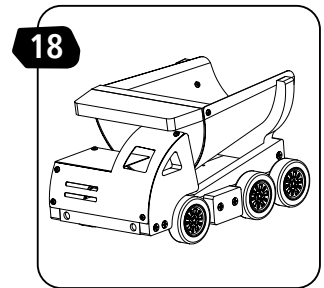
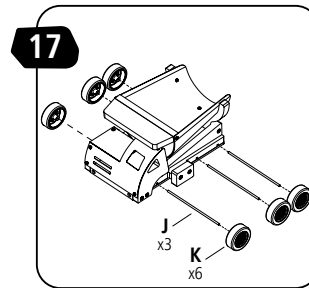
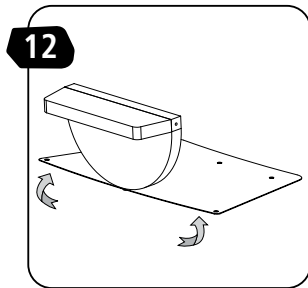
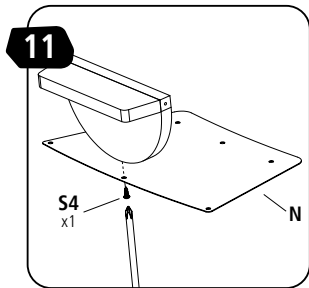
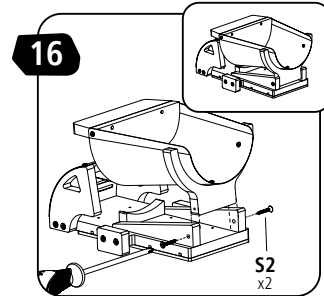
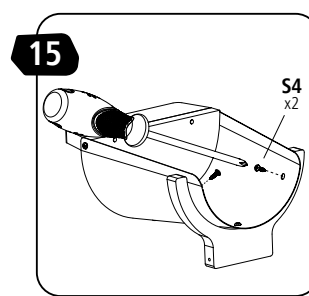
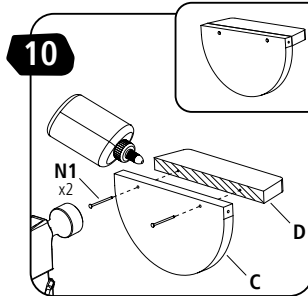
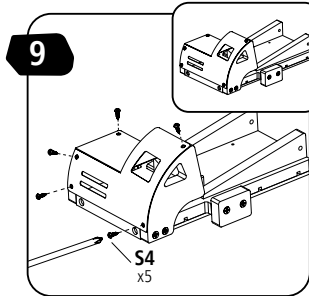
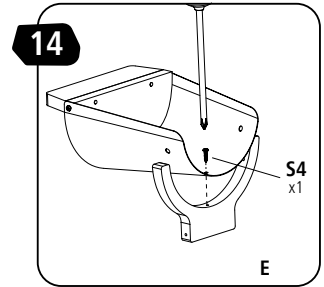
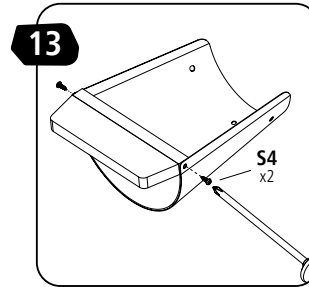
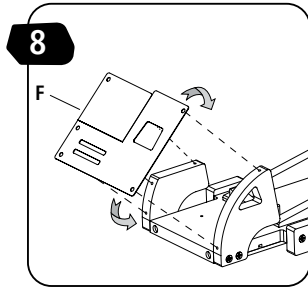
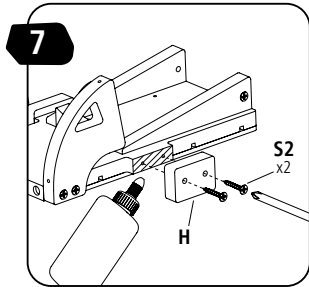

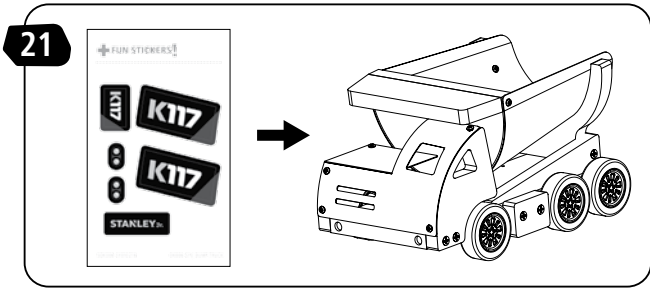
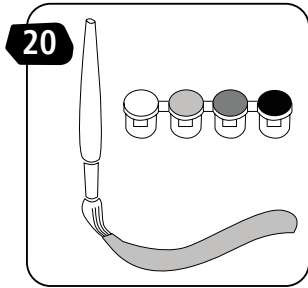
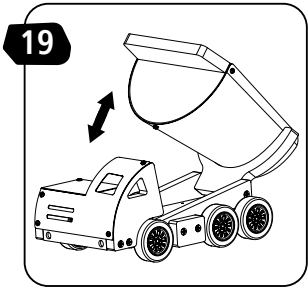



# STANLEY® Jr.

©2019 Stanley Black & Decker, Inc.  
STANLEY®, STANLEY® Jr. and the STANLEY®  
and STANLEY® Jr. logos are trademarks of  
Stanley Black & Decker, Inc. or an affiliate thereof  
and are used under license. All rights reserved.

**Products are manufactured by:**

Red Tool Box Ltd.  
Yun He, Zhejiang Province, China  
Made in China



**WARNING:**

CHOKING HAZARD-

Small parts.

Not for children under 3 yrs.



**CAUTION:**

FUNCTIONAL SHARP POINTS

AND EDGES- Use with care.

Adult Supervision Recommended.